



GAS



ELEKTRO



WASSER



MECHANIK



WERKZEUG

Ersatzteile passend für

MARCFI

Das komplette Sortiment finden Sie immer aktuell im GEV-Webshop

Heizkörper

Heizkörper für Kaffeemaschinen



1

GEV-Nr.	417071	Vergl.-Nr.	N/A
Beschreibung	Heizkörper 1000W 230V HK 2 Einbau ø 40mm LA 52mm L 150mm B 40mm H 26mm Loch ø 9mm Rohr ø 8mm Tauchheizkörper 3-Lochflansch passend für Marcfi Ancas		
Zubehör für	417071		
	GEV-Nr.	528027	Vergl.-Nr.
			—
Beschreibung	Dichtung ID ø 41mm Fiber Materialstärke 2mm Loch ø 10mm LA 50mm für Heizkörper Kaffeetechnik		



1

GEV-Nr.	417069	Vergl.-Nr.	N/A
Beschreibung	Heizkörper 1100W 400V HK 1 Einbau ø 40mm LA 52mm L 330mm B 38mm H 56mm L1 22mm L2 40mm L3 268mm H1 30mm Windungen 1 Loch ø 9mm Anschluss Kabel Tauchheizkörper 3-Lochflansch passend für Marcfi Ancas Kabellänge 108mm		



1

GEV-Nr.	417070	Vergl.-Nr.	N/A
Beschreibung	Heizkörper 1350W 230V HK 1 Einbau ø 40mm LA 52mm L 334mm B 38mm H 30mm L1 20mm L2 40mm L3 270mm H2 21.5mm Windungen 1 Loch ø 9mm Rohr ø 8.5mm Anschluss Kabel Tauchheizkörper 3-Lochflansch passend für Marcfi Ancas Kabellänge 65mm		





1

GEV-Nr.	417504	Vergl.-Nr.	BM-2083 1
Beschreibung	Heizkörper 1500W 220V HK 2 Einbau ø 40mm LA 52mm L 150mm B 40mm H 26mm Loch ø 9mm Rohr ø 8mm Tauchheizkörper passend für Marcfi Ancas Kabellänge 70mm		





1

GEV-Nr.	417072	Vergl.-Nr.	N/A
Beschreibung	Heizkörper 3000W 230V HK 2 Einbau ø 40mm LA 52mm L 355mm B 36mm H 25mm Loch ø 9mm Anschluss Kabel Tauchheizkörper 3-Lochflansch passend für Marcfi Ancas Kabellänge 105mm		
Zubehör für	417072		
	GEV-Nr.	528027	Vergl.-Nr.
			—
Beschreibung	Dichtung ID ø 41mm Fiber Materialstärke 2mm Loch ø 10mm LA 50mm für Heizkörper Kaffeetechnik		



1

GEV-Nr.	417073	Vergl.-Nr.	N/A
Beschreibung	Heizkörper 3000W 400V HK 2 Einbau ø 40mm LA 52mm L 339mm B 37mm H 26mm Loch ø 8mm Rohr ø 8.5mm Anschluss Kabel Tauchheizkörper 3-Lochflansch passend für Marcfi Ancas Kabellänge 80mm		
Zubehör für	417073		
	GEV-Nr.	528027	Vergl.-Nr.
			—
Beschreibung	Dichtung ID ø 41mm Fiber Materialstärke 2mm Loch ø 10mm LA 50mm für Heizkörper Kaffeetechnik		



1

GEV-Nr.	417068	Vergl.-Nr.	N/A
Beschreibung	Heizkörper 650W 230V HK 1 Einbau ø 40mm LA 52mm L 145mm B 34mm H 43mm L1 20mm L2 62mm L3 80mm H1 8mm H2 35mm Windungen 1 Loch ø 9mm Rohr ø 8mm Anschluss Kabel Tauchheizkörper 3-Lochflansch passend für Marcfi Ancas Kabellänge 100mm		

Zubehör

Dichtungsringe

PTFE-Dichtungen

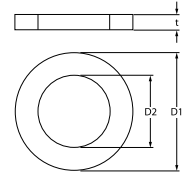
1

GEV-Nr.	528007	Vergl.-Nr.	AB-425 E
Beschreibung	Flachdichtung PTFE AD ø 50mm ID ø 40mm Materialstärke 2.5mm VPE 1 Stück		

Flanschdichtungen



1

GEV-Nr.	528340	Vergl.-Nr.	TKF-5146
Beschreibung	Dichtung ID ø 40.5mm Fiber Materialstärke 3mm Loch ø 10mm LA 52mm für Heizkörper Kaffeetechnik		

Schalter und Taster

Wippschalter/-taster

25,5x25mm



1

GEV-Nr.	347422 ¹	Vergl.-Nr.	BH-2214
Beschreibung	Wippschalter Einbaumaß 25x25mm blau 2NO 250V 10A 0-I Anschluss Flachstecker 6,3mm Schutzart IP40		
Zubehör für	347422		
	GEV-Nr.	301323	Vergl.-Nr.
			—
Beschreibung	Schutzhaube Außenmaß 35x35mm H 11mm transparent passend für Wippschalter Einbaumaß 25,5x25mm L 35mm B 35mm		

¹beleuchtet



Drehschalter

GOTTAK



1

GEV-Nr.	346088	Vergl.-Nr.	N/A
Beschreibung	Drehschalter Stellungen 4 0-1-2-3 400V 16A Achse rund Anschluss Flachstecker		

Lampen

Signallampen

Signallampen komplett

ø 9mm



1

GEV-Nr.	359135	Vergl.-Nr.	BJ-2057
Beschreibung	Signallampe ø 9mm 230V rot Anschluss Flachstecker 6,3mm Temp. Best. 120°C mit Linse		

Schütze

LS Industrial Systems / TS Technical Solu-

Leistungsschütze



1

GEV-Nr.	380922	Vergl.-Nr.	BL-2029
Beschreibung	Leistungsschütz AC1 20A 230VAC (AC3/400V) 5A/2,2kW Hauptkontakte 3NO Hilfskontakte 1NO Anschluss Schraubanschluss Typ GMC-6M		

Relais

Niveaurelais

GICAR



1

GEV-Nr.	402103	Vergl.-Nr.	BH-2226
Beschreibung	Niveauregler 230/240V Spannung AC 50/60Hz Anschluss F6,3 Typ NRL30/1E-2C/F		

Tastaturen

Tastatureinheiten



1

GEV-Nr.	402809	Vergl.-Nr.	BM-2075
Beschreibung	Tastatureinheit für Dosiergerät Tasten 5 passend für Marcfi Ancas		



1

GEV-Nr.	402846	Vergl.-Nr.	BM-2020 BM-2020G
Beschreibung	Tastatureinheit Tasten 5 rot/schwarz passend für Marcfi Ancas Typ 1d5 GRC NKP S10 Beleuchtung LED 250V L 137mm B 43mm		



1

GEV-Nr.	402807	Vergl.-Nr.	BM-2014
Beschreibung	Tastatureinheit Tasten 5 Typ CONTROL d 230V		



Gerätespezifische Bauteile für Espressomaschinen

Siebträger

Siebträger Standard

Siebträger lang



1

GEV-Nr.	529153	Vergl.-Nr.	N/A
Beschreibung	Siebträger Befestigung ø 75mm Loch ø 8mm Auslauf 3/8" ID ø 63.5mm Griff M8 Keilzahl 3		

Siebe

für 1 Tasse



1

GEV-Nr.	529100	Vergl.-Nr.	N/A
Beschreibung	Kaffeefilter ø 66.5mm Einbau ø 57mm H 25mm Tassen 1 Kaffeemenge 7g		



1

GEV-Nr.	529098	Vergl.-Nr.	N/A
Beschreibung	Kaffeefilter ø 70mm Einbau ø 60.3mm H 22mm Tassen 1 Kaffeemenge 7g		

für 2 Tassen



1

GEV-Nr.	529101	Vergl.-Nr.	N/A
Beschreibung	Kaffeefilter ø 67mm Einbau ø 57mm H 25mm Tassen 2 Kaffeemenge 14g		



1

GEV-Nr.	529099	Vergl.-Nr.	N/A
Beschreibung	Kaffeefilter ø 70mm Einbau ø 60.7mm H 22mm Tassen 2 Kaffeemenge 14g		

Brühgruppen

Duschensiebe

flach



1

GEV-Nr.	529136	Vergl.-Nr.	N/A
Beschreibung	Duschensieb ø 51.6mm Loch ø 13.1mm		



1

GEV-Nr.	529138	Vergl.-Nr.	BJ-5394
Beschreibung	Duschensieb ø 54.6mm Loch ø 10mm Typ M-920		

mit Aufkantung



1

GEV-Nr.	529140	Vergl.-Nr.	N/A
Beschreibung	Duschensieb ø 59.5mm H 12.5mm		

Siebträgerdichtungen

flach

Standard



1

GEV-Nr.	528059	Vergl.-Nr.	N/A
Beschreibung	Siebträgerdichtung D1 ø 65mm D2 ø 53mm H 5.3mm VPE 1 Stück		



1

GEV-Nr.	528060	Vergl.-Nr.	N/A
Beschreibung	Siebträgerdichtung D1 ø 73.5mm D2 ø 59.5mm H 7.5mm VPE 1 Stück		



1

GEV-Nr.	528061	Vergl.-Nr.	N/A
Beschreibung	Siebträgerdichtung D1 ø 73mm D2 ø 59mm H 8.5mm VPE 1 Stück		

Brühgruppen manuell

Einzelteile

Dichtungen



1

GEV-Nr.	526856	Vergl.-Nr.	E-732
Beschreibung	Dichtung D1 ø 13mm ID ø 4mm Materialstärke 4mm Viton		

Einzelteile

Düsen

mit Gewinde



1

GEV-Nr.	526889	Vergl.-Nr.	F.2.003
Beschreibung	Düse Bohrung ø 0.6mm Gewinde M5 L 20mm		

Schrauben



1

GEV-Nr.	531051	Vergl.-Nr.	BH-5921 I
Beschreibung	Schraube Gewinde M10x1,5 L 19mm Gewinde L 6mm Edelstahl VPE 1 Stück Aufnahme Schlitz Edition bis Juli 2002		

Dichtungen



1

GEV-Nr.	529189	Vergl.-Nr.	TKD-5053
Beschreibung	Gruppendichtung L 91mm B 73mm Materialstärke 2mm LA 58mm passend für Marcfi Ancas Fiber		

Wasserverteiler

Wasserverteiler

Gruppe 3



1

GEV-Nr.	531043	Vergl.-Nr.	BH-5920 L
Beschreibung	Wasserverteiler ø 59mm H 13mm 10 Löcher Loch ø 10mm Messing Lochung ø 1.8mm		

2-teilig



1

GEV-Nr.	529149	Vergl.-Nr.	N/A
Beschreibung	Wasserverteiler D1 ø 16mm D2 ø 13mm Gewinde M10x1,5 Loch ø 2mm Lochung ø 1mm 4 Löcher H 13.3mm Messing passend für Marcfi Ancas		



1

GEV-Nr.	529128	Vergl.-Nr.	N/A
Beschreibung	Wasserverteiler D1 ø 53.5mm Gewinde M10x1,5 H 15mm Messing passend für Marcfi Ancas Befestigung ø 6.1mm Bohrung ø 11mm		

Ablaufwannen

Ablaufwannen



1

GEV-Nr.	531039	Vergl.-Nr.	BM-5145
Beschreibung	Ablaufwanne L 305mm B 110mm passend für Marcfi Ancas		

Dampf-/Wasserhähne

Dampf-/Wasserhähne

Einzelteile

Dichtungen



1

GEV-Nr.	526856	Vergl.-Nr.	E-732
Beschreibung	Dichtung D1 ø 13mm ID ø 4mm Materialstärke 4mm Viton		

Dampf-/Wasserrohre

Dampfrohre



1

GEV-Nr.	531036	Vergl.-Nr.	BM-2022
Beschreibung	Dampfrohr Edition bis März 2005 passend für Marcfi Ancas		



1

GEV-Nr.	531048	Vergl.-Nr.	BM-2113
Beschreibung	Dampfrohr Gewinde 3/8" ø 14mm Rohr ø 10mm		



1

GEV-Nr.	531037	Vergl.-Nr.	BM-2041
Beschreibung	Dampfrohr Gewinde 3/8" ø 14mm Rohr ø 8mm für Gerät M 990, M 920 & A 93 Edition bis Mai 2006 passend für Marcfi Ancas		

Wasserrohre



1

GEV-Nr.	531049	Vergl.-Nr.	BM-2111
Beschreibung	Wasserrohr Gewinde 3/8" ø 24mm Rohr ø 8mm passend für Marcfi Ancas für Gerät M 990		

Feinfilter

Feinfilter



1

GEV-Nr.	528788	Vergl.-Nr.	BM-5101
Beschreibung	Feinfilter Rohr ø 11mm H 10mm		

Füllventile

Füllventile



1

GEV-Nr.	531034	Vergl.-Nr.	BL-2011
Beschreibung	Füllventil Eingang 3/8" Ausgang 3/8" für Marcfi Ancas		

Niveauschaugläser

Niveauschaugläser

Schauglasrohre



1

GEV-Nr.	529438	Vergl.-Nr.	N/A
Beschreibung	Füllstandsrohr ø 13mm H 113mm für Serie M-920		

Verschraubungen



1

GEV-Nr.	526891	Vergl.-Nr.	L120/1CR
Beschreibung	Verschraubung Gewinde M10 Loch ø 3.8mm H 33mm SW 12 verchromt		

Knebel

Dampf-/Wasserhähne

Dampf-/Wasserhähne



1

GEV-Nr.	111398	Vergl.-Nr.	BL-3046 BM-3162
Beschreibung	Drehgriff ø 39.5mm L 50mm Achse 7,5x7,5mm schwarz		

Dichtungen

O-Ringe

EPDM

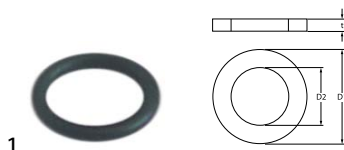

1

GEV-Nr.	528333	Vergl.-Nr.	TKF-5071
Beschreibung	O-Ring EPDM Materialstärke 2.62mm ID ø 13.1mm VPE 1 Stück		

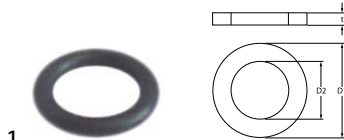

1

GEV-Nr.	528487	Vergl.-Nr.	A-266
Beschreibung	O-Ring EPDM Materialstärke 2.62mm ID ø 9.19mm VPE 1 Stück		

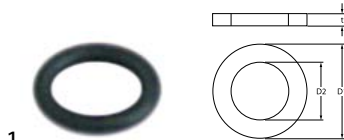

1

GEV-Nr.	528396	Vergl.-Nr.	TKF-5153
Beschreibung	O-Ring EPDM Materialstärke 2mm ID ø 7.2mm VPE 1 Stück		

Viton

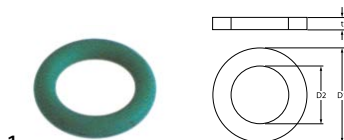

1

GEV-Nr.	531030	Vergl.-Nr.	TKF-5151 TKF-5154
Beschreibung	O-Ring Viton Materialstärke 2.62mm ID ø 9.19mm VPE 1 Stück		

PTFE

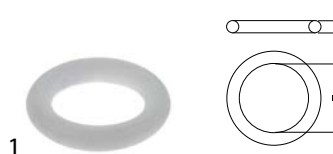

1

GEV-Nr.	528217	Vergl.-Nr.	TKF-5140
Beschreibung	O-Ring PTFE Materialstärke 2.62mm ID ø 9.92mm VPE 1 Stück		

Dichtungsringe

Aluminiumdichtungen



1

GEV-Nr.	560307	Vergl.-Nr.	TKA-5001
Beschreibung	Flachdichtung Aluminium AD ø 21mm ID ø 17mm Materialstärke 1.5mm VPE 1 Stück		

PTFE-Dichtungen



1

GEV-Nr.	528007	Vergl.-Nr.	AB-425 E
Beschreibung	Flachdichtung PTFE AD ø 50mm ID ø 40mm Materialstärke 2.5mm VPE 1 Stück		

Spezialdichtungen

Gruppendichtungen



1

GEV-Nr.	529189	Vergl.-Nr.	TKD-5053
Beschreibung	Gruppendichtung L 91mm B 73mm Materialstärke 2mm LA 58mm passend für Marcfi Ancas Fiber		



1

GEV-Nr.	529169	Vergl.-Nr.	N/A
Beschreibung	Gruppendichtung L 79.5mm B 79.5mm Materialstärke 3mm passend für Marcfi Ancas LA 55mm		

Manometer

			
1			
GEV-Nr.	541612	Vergl.-Nr.	BL-2014 BL-2015
Beschreibung	Manometer Doppelskala ø 63mm Druckbereich 0-3 / 0-15bar Anschluss rückseitig Gewinde 1/4" / 1/8" mit Adapter für Marcfi Ancas		

			
1			
GEV-Nr.	541777	Vergl.-Nr.	BL-2014
Beschreibung	Manometer Doppelskala ø 63mm Druckbereich 0-3 / 0-15bar Anschluss rückseitig Gewinde 1/8"		

			
1			
GEV-Nr.	541284	Vergl.-Nr.	N/A
Beschreibung	Manometer ø 52mm Druckbereich 0 bis 15bar Anschluss rückseitig Markierung 6/7 Gewinde 1/4"		

			
1			
GEV-Nr.	541250	Vergl.-Nr.	N/A
Beschreibung	Manometer ø 72mm Druckbereich 0 bis 3bar Gewinde 1/4" Markierung 0,7-1 Anschluss rückseitig		

D

Dichtungsringe	8
Drehschalter	4

H

Heizkörper	3
Heizkörper für Kaffeemaschinen	3

L

Lampen	4
--------	---

O

O-Ringe	8
---------	---

R

Relais	4
--------	---

S

Schalter und Taster	3
Schütze	4
Signallampen	4
Signallampen komplett	4

W

Wippenschalter/-taster	3
------------------------	---